

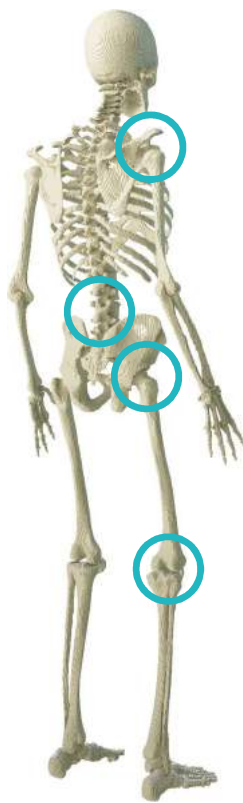

Kammerer Medical Group

Standard-Instrumente



das Original



kammerer-med.de



Weber Instrumente GmbH & Co. KG



Gemeinsam innovieren, gemeinsam wachsen

Was kann ein Medizingerätehersteller von der Automobilindustrie lernen? Eine ganze Menge! So setzen die Autobauer etwa auf eine langfristige Zusammenarbeit mit ihren Lieferanten und lagern ganze Entwicklungsschritte aus. Die Weber Instrumente GmbH & Co. KG positioniert sich ebenfalls als langfristiger Partner: Der Spezialist für OP-Werkzeuge entwickelt Innovationen in enger Kooperation mit seinen Kunden, den großen Implantatateherstellern, und schafft zugleich einen rechtssicheren Rahmen für die Produkte.

Schon vor Jahrzehnten hatte sich Weber Instrumente mit dem vom Firmengründer erfundenen „Weber-Griff“ den Ruf eines Innovators erworben. Denn bei diesem neuartigen Griff konnten sich zwischen Silikon und Stahl keine Keime ansiedeln. Seit gut zehn Jahren ist das Unternehmen nun unter neuer Leitung: Uli Kammerer, der jetzige Inhaber, war früher in der Automobilbranche tätig und spezialisierte sich anschließend auf die Mittelstandsberatung in den Bereichen Unternehmensstrategie und Geschäftsprozessoptimierung. Durch den Einstieg in die Weber Instrumente GmbH & Co. KG wechselte Kammerer vom Berater zum Gestalter – und das mit großem Erfolg.

Dokumentation als Dienstleistung

Unter Kammerers Ägide hat man das Wirkungsfeld deutlich ausgeweitet: Zu den OP-Werkzeugen für die Wirbelsäulenchirurgie kamen OP-Sets für das Einsetzen von Hüft-, Knie- und Schulterimplantaten hinzu. Zudem wandelte sich die Firma vom Instrumentenhersteller zum Komplettanbieter und baute sein Dienstleistungsangebot aus. Für die Auftraggeber hat das einen entscheidenden Vorteil: Da Weber Instrumente

- die notwendige Dokumentationstätigkeit mit übernimmt, können die Kunden ihre neuen Produkte wesentlich einfacher zulassen – und das, obwohl die Anforderungen durch die neue EU-Medizinprodukteverordnung deutlich gestiegen sind.

Wertschöpfung vergrößert

- Während andere Unternehmen durch die Medizinprodukteverordnung ins Schleudern gerieten, blühte die ser Mittelständler aus Baden-Württemberg regelrecht auf: Allein von 2017 auf 2018 stieg der Umsatz um mehr als 40 %. Die Firma hat ihre eigene Wertschöpfung deutlich vergrößert, sie beteiligte sich an Unterlieferanten, will neu bauen und künftig als Teil der im Aufbau befindlichen Kammerer Medical Group weiter expandieren. Eine Expansion, die wirtschaftlich gut abgesichert ist, weil die Verträge mit den wichtigsten Kunden längst langfristig abgeschlossen sind. Gemeinsam innovativ sein und gemeinsam wachsen – diese Strategie überzeugt nicht nur in der Automobilindustrie.

Innovationshelden

top 100 ist seit 27 Jahren der einzige Wettbewerb in Deutschland, der das Innovationsmanagement und den Innovationserfolg mittelständischer Unternehmen auszeichnet. Das heißt: top 100 bewertet keine einzelnen Produkte, sondern nimmt alle Stufen des Innovationsprozesses genau unter die Lupe. Folgende Kategorien werden dabei geprüft: „Innovationserfolg“, „Innovationsklima“, „Innovative Prozesse und Organisation“, „Außenorientierung/ Open Innovation“ und „Innovationsförderndes Top-Management“.

- Ausrichter von top 100 ist die compamedia GmbH. Als Mentor unterstützt der Wissenschaftsjournalist Ranga Yogeshwar den Wettbewerb. Darüber, welche Unternehmen das top 100-Siegel tragen dürfen, entscheidet allein der wissenschaftliche Leiter des Wettbewerbs: Prof. Dr. Nikolaus Franke von der Wirtschaftsuniversität Wien, einer der weltweit führenden Innovationsforscher. Die Weber Instrumente GmbH & Co. KG hat sich in einem starken Teilnehmerfeld durchgesetzt. Da mit zählt das Unternehmen 2020 zum 5. Mal zu den Top-Innovatoren.



Weber Instrumente GmbH & Co. KG



Joint innovation, shared growth

What can a medical equipment manufacturer learn from the automotive industry? Quite a lot, actually. Car manufacturers rely on long-term partnerships with their suppliers and outsource entire development stages, for example. Weber Instrumente GmbH & Co KG positions itself as a long-term partner too. The surgical tools specialist works closely with its customers, the major implant manufacturers, on the development of innovative products while ensuring they are legally compliant.

Weber Instrumente gained a reputation as an innovator decades ago thanks to the 'Weber handle' invented by the company's founder. This new type of handle made it impossible for germs to take hold between silicone and steel. The company has been under new management for a good ten years now. Current owner Uli Kammerer worked in the automotive industry before specialising in corporate strategy and business process optimisation consulting for medium-sized companies. The move to Weber Instrumente GmbH & Co. KG saw Kammerer evolve very successfully from a consultant into a designer.

Documentation as a service

Under Kammerer's stewardship, the field of activity has been significantly expanded, with surgical sets for the insertion of hip, knee and shoulder implants added to the existing range of surgical tools for spinal surgery. The company has also been transformed from a tool manufacturer into a full-service provider with an extended portfolio of services. This has a crucial benefit for customers: as Weber Instrumente GmbH & Co. KG takes care of the necessary documentation,

customers can get their new products approved much more easily – despite the fact that the requirements have increased significantly under the new EU Medical Devices Directive.

Greater added value

While the Medical Devices Directive sent other companies into a tailspin, this Baden-Württemberg-based SME went stratospheric, with revenue increasing by over 40 % between 2017 and 2018. The company has significantly increased its own value creation and has acquired stakes in subcontractors. It also plans to build new facilities and will continue to expand in the future as part of the Kammerer Medical Group, which is currently being established. This expansion is on a secure commercial footing because long-term contracts with key customers were concluded some time ago. Joint innovation and shared growth – a strategy that is proving its worth outside of the automotive sector too.

Innovation superheroes

top 100 is a unique competition that has been recognising the innovation management systems and the successful innovations of Germany's small and medium-sized enterprises for 27 years now. top 100 does not judge individual products, but takes a very close look at all stages of the innovation process. It examines five categories: 'Successful Innovations', 'Climate of Innovation', 'Innovative Processes and Organisation', 'Outward Looking/Open Innovation' and 'Innovation-friendly Senior Management'.

The top 100 competition is organised by compamedia GmbH and mentored by science journalist Ranga Yogeshwar. The winners of the top 100 award are decided solely by the head of the competition's research team, Professor Nikolaus Franke from the Vienna University of Economics and Business, one of the world's leading innovation researchers. Weber Instrumente GmbH & Co. KG stood out in a strong field. The company is thus one of the top innovators in 2020.

Griffe | handles

softgrip Mod. 9

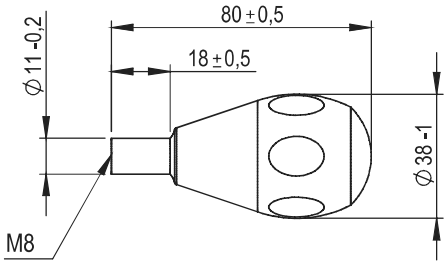

softgrip Mod. 8

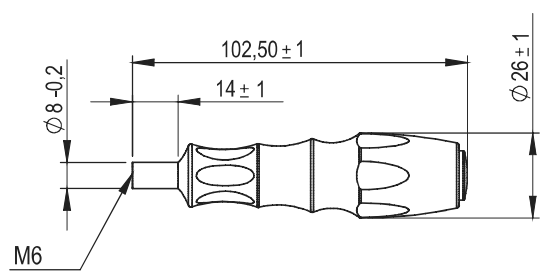

softgrip Mod. 37

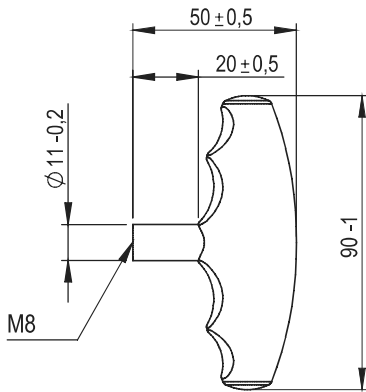

softgrip Mod. 79

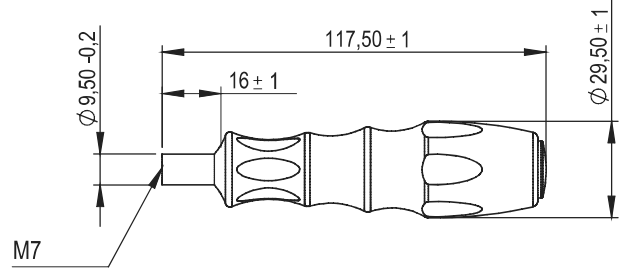

softgrip Mod. 0

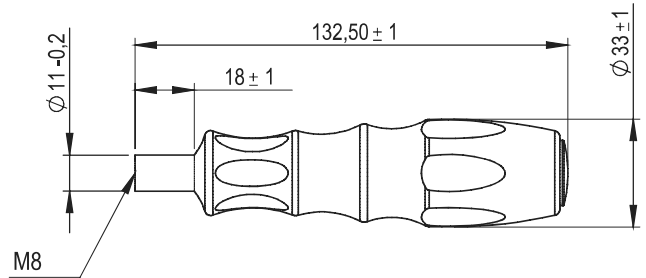

softgrip Mod. I

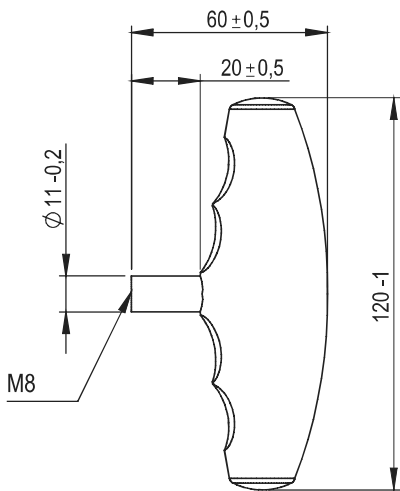

softgrip Mod. 24

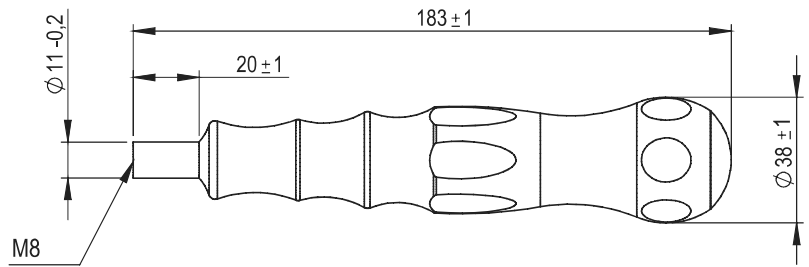

softgrip Mod. 88

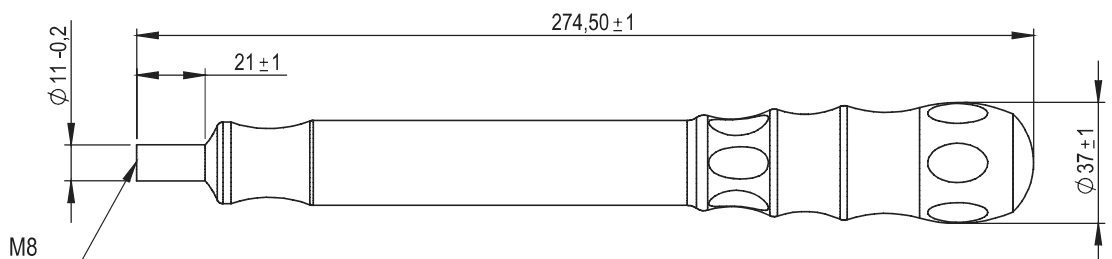

Griffe | handles

softgrip Mod. 144

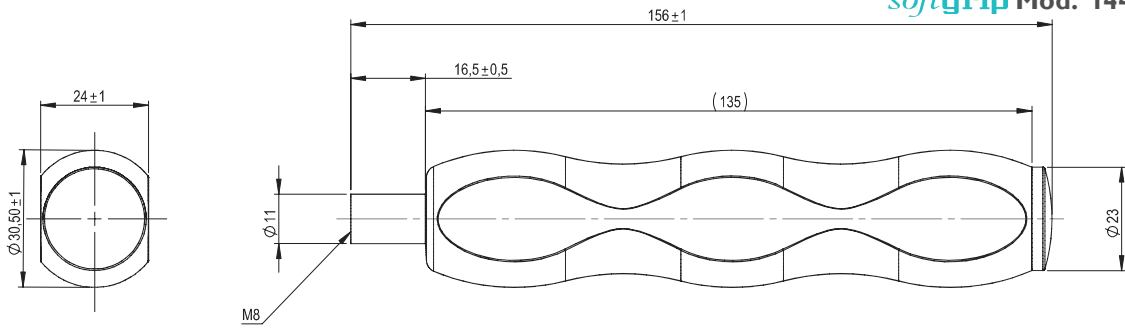

softgrip Mod. 139

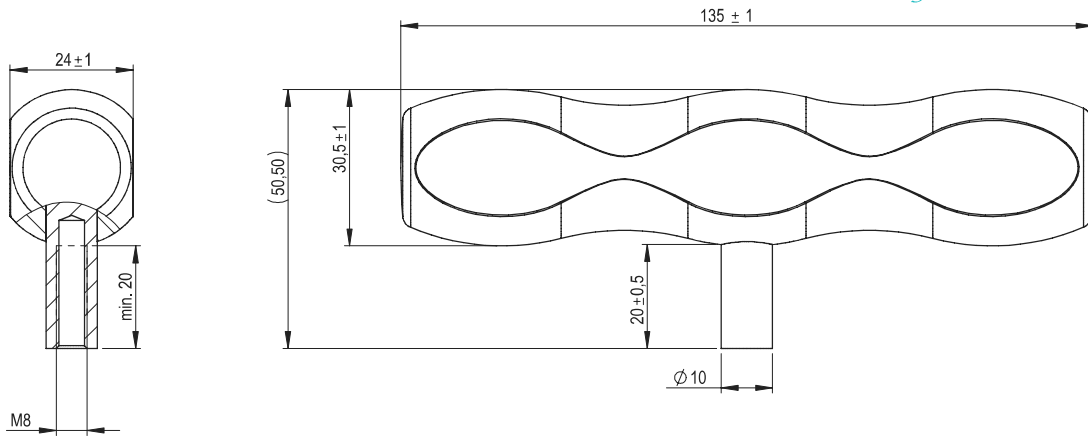

softgrip Mod. 141

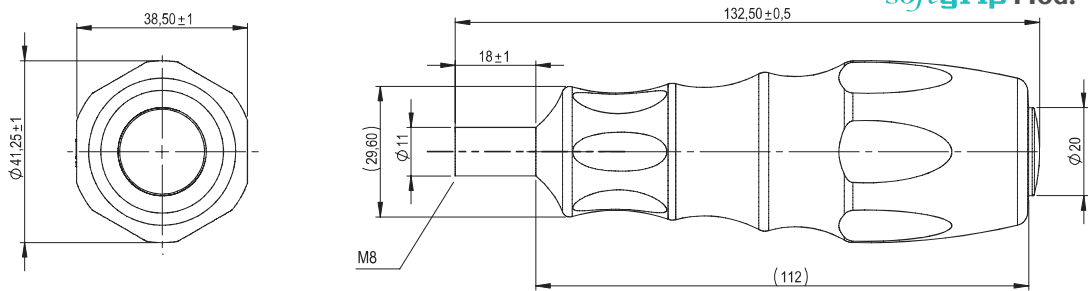

softgrip Mod. 142

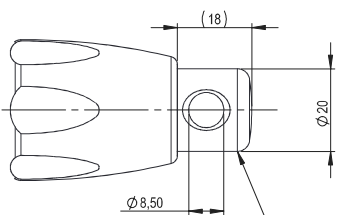
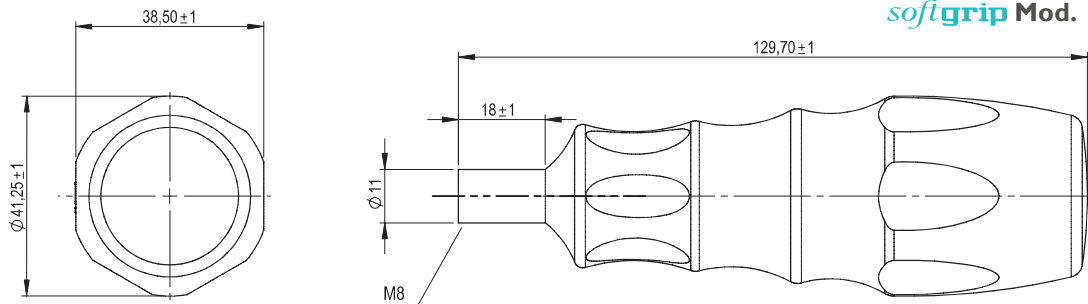

Schlagkappe mit Bohrung Ø8,5 aus Edelstahl

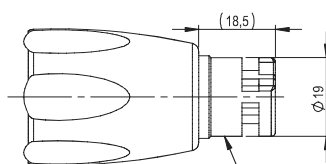

Bajonettkappe aus Edelstahl

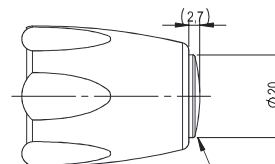

Schlagkappe aus Edelstahl

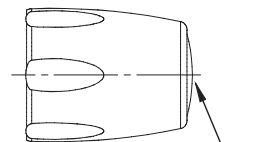

Ohne Schlagkappe, Silikon rundum

Griffe | handles

softgrip Mod. 88



softgrip Mod. 37



softgrip Mod. 1



softgrip Mod. 9



softgrip Mod. 24



softgrip Mod. 0



softgrip Mod. 79



softgrip Mod. 8



Griffe | handles



softgrip Mod. 139



softgrip Mod. 145



Schlagkappe aus Edelstahl mit Bohrung



Bajonettkappe aus Edelstahl



Schlagkappe aus Edelstahl



Ohne Schlagkappe Silikon rundum

WEBER Farbauswahl für *softgrip*



schwarz

grün

dunkelblau

hellblau

rot

orange

gelb

Kupplungen | coupling systems



AO



1/4"



Hall Jacobs



Hudson



WEB A



WEB B



WEB C

Kupplungs - art / Coupling type	WEB A	WEB B	WEB C	1/4" Vierkant / 1/4" square-cut	Hall-Jacobs	AO	Hudson
Drehmoment / maximum torque	20Nm	10Nm	20Nm	20Nm	20Nm	7Nm	10Nm
Übertragbare Axialkräfte / transferable axial forces	hoch in beide Richtungen / high in both directions	hoch in Arbeitsrichtung, klein in Gegenrichtung / high in working direction, low against working direction	hoch in Arbeitsrichtung, klein in Gegenrichtung / high in working direction, low against working direction	klein in beide Richtungen / low in both directions	klein in beide Richtungen / low in both directions	klein in beide Richtungen / low in both directions	klein in beide Richtungen / low in both directions
Axiale Kraftübertragung / axial force transfer	Ringfläche - Ringfläche / ring surface - ring surface	Ringfläche - Kugel / ring surface - ball	Ringfläche - Kugel / ring surface - ball	Kugel - Kugel / ball - ball	Kugel - Kugel / ball - ball	Kugel - Kugel / ball - ball	Kugel - Kugel / ball - ball
Kanülierung max. / max. cannulation	Ø 3,2mm	Ø 2,6mm	Ø 7,5mm	Ø 4,5mm	Ø 5,0mm	Ø 1,2mm	Ø 3,2mm
Handhabung / operation	Druckkopf sicher und einfach, rastet selbst ein / button, save and easy to use. Latches itself.	Schiebehülse beim Einsetzen und Lösen betätigen / latching/unlatching by operation of sliding sleeve	Schiebehülse beim Einsetzen und Lösen betätigen / latching/unlatching by operation of sliding sleeve	Schiebehülse beim Einsetzen und Lösen betätigen / latching/unlatching by operation of sliding sleeve	Schiebehülse beim Einsetzen und Lösen betätigen / latching/unlatching by operation of sliding sleeve	Schiebehülse beim Einsetzen und Lösen betätigen / latching/unlatching by operation of sliding sleeve	Schiebehülse beim Einsetzen und Lösen betätigen / latching/unlatching by operation of sliding sleeve

Kupplungen und Ratschen | quick connect systems

Dental



AO



1/4"



WEB A Kupplung für hohe Axialkräfte in Arbeitsrichtung
WEB A coupling for high axial forces in working direction



WEB A Kupplung und WEB Anschluss für Axialkräfte in beide Richtungen
WEB A coupling and WEB connection for high axial forces in both direction



WEB A Kupplung mit T-Griff für hohe Drehmomente
WEB A coupling with T-handle for high torque moments



WEB A Ratsche mit selbsthaltendem Schraubendreher für mono- und polyaxiale Pedikelschrauben
WEB A ratcheting handle with self-retaining screwdriver for mono- and polyaxial pedicle screws



WEB C Kupplung mit Hohlfräser max. Kanülierung Ø 7,5mm
WEB C quick connect handle with hollow chamfer max. cannulation Ø 7,5mm



Kupplungen und Ratschen | quick connect systems

Schraubendreher
screwdriver



Schraubendreherschaft T-Griff Ratsche
screwdriver shaft T-handle ratcheting



selbsthaltender Schraubendreher
self-retaining screwdriver



Drehmomentschraubendreher
torque wrench screwdriver



Drehmomentschraubendreher mit Gegenhalter
torque wrench screwdriver with counter torque



Drehmomentschraubendreher mit AO Kupplung
torque indicator with AO quick connection



Modular Spine Distraktor und Kompressor modular spine distractor and compressor



Modular Spine Distraktor
modular spine distractor



Modular Spine Kompressor
modular spine compressor



spezielle Valven für MSD / MSK
special tips for MSD / MSK



Gabel-Valven für MSD / MSK
fork-tips for MSD / MSK



Teller-Valven für MSD / MSK
flat tips for MSD / MSK



Universal-Valven für MSD / MSK
universal-tips for MSD / MSK



Wirbelsäule | spine

Saugdistraktor
suction distractor



Nervenhaken
nerve retractor



Caspar Distraktor für die cervicale Wirbelsäule
caspar distractor for cervical spine



Tiefenmesser
depth gauge



Dilatatoren-Set
dilator set



Nervenhaken
nerve hook



Implantateinsetzer-Set | fusion set



Stabdrücker
alignment instrument



Pedikelschrauben Instrumenten Set
pedicle screws instrument set



Flügel-Abbrechzange
screw head cutter



Implantateinsetzer
implant inserter



Hämmer | mallets

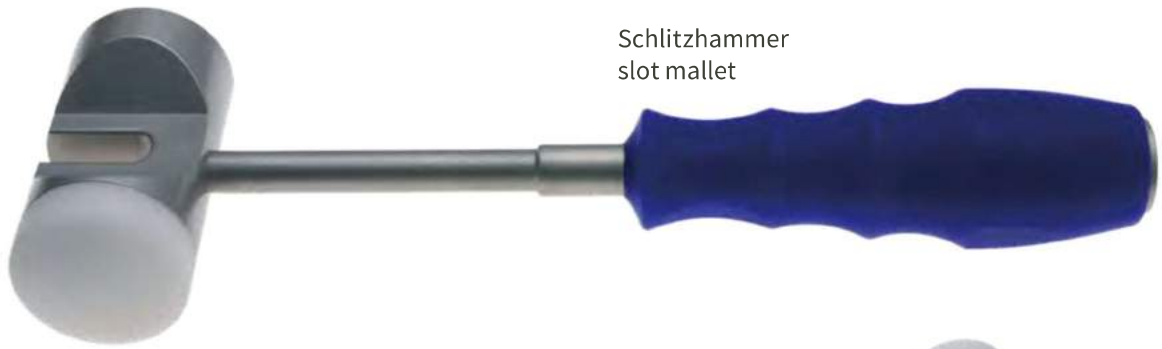

Schlitzhammer
slot mallet



rückschlagfreier Hammer
blow-back proofed mallet



Zweiweg-Hammer
two-way mallet



Schlitzhammer mit flachem Kopf
slot mallet with flat hammer head



Küretten, Feilen, Löffel | curettes, rasps, spoons



Knochenfeile
bone rasp



Löffel gezahnt
spoon curette



Schlingenkürette
loop curette



Rechteckkürette
box curette



Bohrer, Ahle, Raspel, Pfriem | drill, reamer, rasp, awl

kanülierter Bohrer
canulated drill



kanülierte Reibahle
canulated reamer



Cobb Raspatorium klein
cobb spinal rasp small



Cobb Raspatorium groß
cobb spinal rasp large



Pfriem
awl



Osteotom
chisel



Küretten, Feilen, Löffel | currettes, rasps, spoons

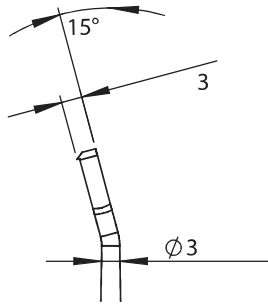

W 45 - 013

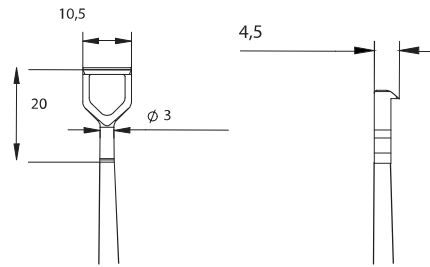

W 45 - 121

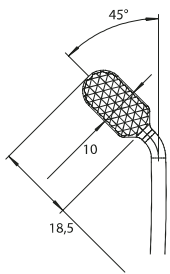

W 47 - 212

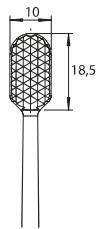

W 47 - 208

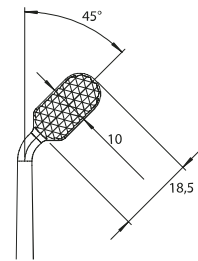
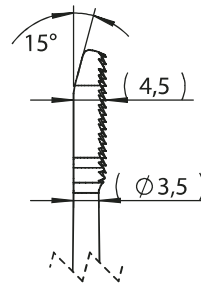

W 47 - 213

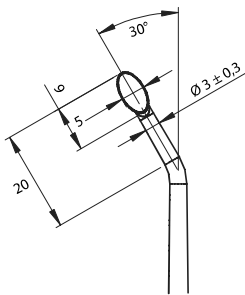

W 45 - 278

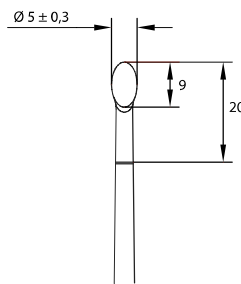

W 45 - 236

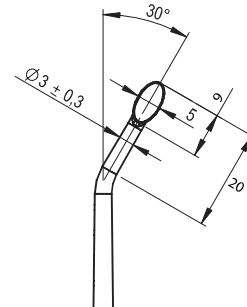

W 45 - 277

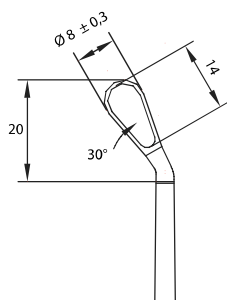

W 45 - 132

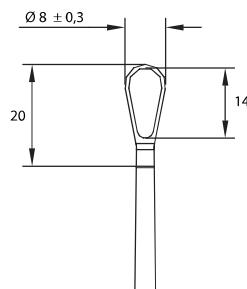

W 45 - 128

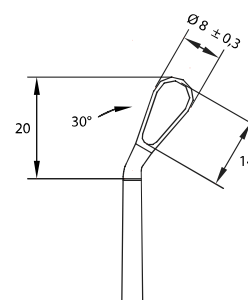

W 45 - 131

Hüfte, Knie, Schulter | hip, knee, shoulder

Drehmomentschraubendreher
torque indicator



Tiefenmesser
depth gauge



Bohrlehre
drill guide



Patella-Zange
patella holder

Knochenzange
forceps



Stabfaßzange
rod holder



Wirbelheber
rocker



Implantateinsetzer
implant holder



Bohrschablonenhalter
position device



U17-Europameisterinnen und
U17-Vize-Weltmeisterinnen 2022
Amelie Rinn und Amelie Wehrle,
Jollensegler Reichenau,
gesponsort von Kammerer
Medical Group



Kammerer Medical Group

Im Saegenloh 3
D-78333 Stockach

Fon +49 7771 64711-0
info@kammerer-med.de

kammerer-med.de

Abbildungen und Beschreibungen unserer Produkte
Wir behalten uns produktionsstechnisch bedingte
Änderungen sowie Änderungen in Form und
Farbe vor. Die verwendeten Produktabbildungen
können in Form und Farbe abweichen. Die für
unsere Produkte angegebenen Maße sind
definierte Richtwerte.

Illustration and descriptions of our products
We reserve the right to perform product related
modifications including changes to form and
colour. The product images used may have
deviations in shape and colour. The dimensions
given are specific guidelines.

